

P.C.B Layout(copper-sided view)

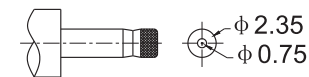

DC MATE PLUG

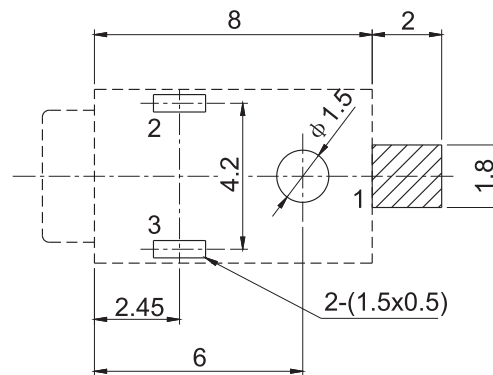
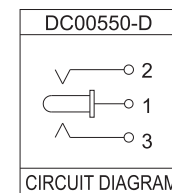

主要技术参数、性能

The Main Thchnology Performance

额定电流、电压 Rate voltage current	DC 30V 0.5A
接触电阻 Contact resistance	≤100mΩ
绝缘电阻 insulated resistance	≥100mΩ DC 500V
耐受电压 Withstand Voltage	AC 500V (50-60HZ)1min
电寿命 Electrical Life	5000 Cycles
使用温度 Service temperature	-25°C+ 80 °C
使用湿度 Ambient humidity used	≤85%RH
耐焊温度 Withstand Soldering temperature	260°C ± 5°C 5S ± 1S

E				
D				
C				
B				
A				
项目 ITEM	名称 DESCRIPTION	材质 MATERIAL	数量 QYT	表面处理/颜色 FINSH/COLOR

						第一视角 FIRST VIEW		名称/NAME: DC插座 DC POWER JACK	
								型号/MODEL: DC055	
标记 SING	处数 FREQUENCY	更改文件号 REVISION	签名 APPROVED	日期 DATE	比列 SCALE	一般公差 GENERAL TOLERANCE			
设计 DESIGN		Zhaoming		单位 UNIT	mm	0.5~2	±0.10		
审核 CHECKED		Zengyong		重量 WELGHT		2~5	±0.15		
批准 APPROVED		Fuyunfeng				5~10	±0.20		
							角度 ANGLE	±0.5°	